

EasySolar

12 | 1600 | 70-16 230V

24 | 1600 | 40-16 230V

1. SAFETY INSTRUCTIONS

General

Please familiarize yourself with the safety features and instructions by first reading the documentation supplied with this product before using the equipment. This product has been designed and tested in accordance with international standards. The equipment must be used exclusively for the purpose for which it was designed.

WARNING: ELECTRIC SHOCK HAZARD.

The product is used in conjunction with a permanent energy source (battery). Input and/or output terminals may still be dangerously energized, even when the equipment is switched off. Always switch off the AC supply and the battery before carrying out maintenance or servicing the product.

The product has no internal user-serviceable components. Do not remove the front plate or operate the product if any panels have been removed. All servicing must be undertaken by qualified personnel.

Never use the product where there is a risk of gas or dust explosions. Consult the battery manufacturer's information to ascertain that the product is intended for use in conjunction with the battery. Always comply with the battery manufacturer's safety instructions.

WARNING: Do not lift heavy loads without assistance.

Installation

Read the installation instructions in the installation manual before installing the equipment.

This is a Safety Class I product (supplied with a protective grounding terminal).

Uninterruptible protective grounding must be provided at the AC input and/or output terminals. Alternatively the grounding point located externally on the product may be used. Whenever it is likely that the grounding protection has been damaged, the product must be turned off and secured against unintended operation; please contact qualified service staff.

Ensure that the DC and AC input cables are fused and fitted with circuit breakers. Never replace a safety component with a different type. Consult the manual to determine the correct component.

Before applying power, ensure that the available power source matches the configuration settings of the product as described in the manual.

Ensure that the equipment is used under the correct ambient conditions. Never operate the product in a wet or dusty environment. Ensure there is adequate free space for ventilation around the product and check that the ventilation vents are not blocked.

Ensure that the required system voltage does not exceed the product's capacity.

Transport and Storage

Ensure that the mains power and battery cables have been disconnected before storing or transporting the product.

No liability can be accepted for any transport damage if the equipment is shipped in non-original packaging.

Store the product in a dry environment; the storage temperature must be between -40°C and 60°C.

Consult the battery manufacturer's manual in respect of transport, storage, charging, recharging and disposal of the battery.

2. DESCRIPTION

2.1 General

All-in-one solar power solution

The Easy Solar combines a MPPT solar charge controller, an inverter/charger and AC distribution in one enclosure.

The product is easy to install, with a minimum of wiring.

Solar charge controller: Blue Solar MPPT 75/50

Up to three strings of PV panels can be connected with three sets of MC4 (PV-ST01) PV connectors.

Inverter/charger: Phoenix EasyPlus 24/1600/70 or 24/1600/40

The MPPT charge controller and the EasyPlus inverter/charger share the DC battery cables (included). The batteries can be charged with solar power (MPPT) and/or with AC power (inverter/charger) from the utility grid or a genset.

AC distribution

The AC distribution consists of a RCD (30mA/16A) and four AC outputs protected by two 10A and two 16A circuit breakers.

One 16A output is controlled by the AC input: it will switch on only when AC is available.

PowerAssist

Unique PowerAssist technology protects the utility or generator supply from being overloaded by adding extra inverter power when needed.

2.2 Inverter

MultiPlus Compact-functional

The MultiPlus Compact gets its name from the multiple functions it can perform. It is a powerful true sine wave inverter, a sophisticated battery charger that features adaptive charge technology and a high-speed AC transfer switch in a single compact enclosure. Beside these primary functions, however, the MultiPlus Compact has several advanced features that provide a range of new applications as outlined below.

Uninterrupted AC power

In the event of a grid failure, or shore or generator power being disconnected, the inverter within the MultiPlus Compact is automatically activated and takes over supply to the connected loads. This happens so fast (less than 20 milliseconds) that computers and other electronic equipment will continue to operate without disruption.

Parallel and 3-phase operation capability

Up to 6 inverters can operate in parallel to achieve higher power output. Operation in 3-phase configuration is also possible.

PowerControl – Dealing with limited generator or shore side power

With a Multi Control Panel a maximum generator or shore current can be set. The MultiPlus Compact will then take account of other AC loads and use whatever is extra for charging, thus preventing the generator or shore supply from being overloaded.

PowerAssist – Boosting the capacity of shore or generator power

This feature takes the principle of PowerControl to a further dimension allowing the MultiPlus Compact to supplement the capacity of the alternative source. Where peak power is so often required only for a limited period, it is possible to reduce the size of generator needed or conversely enable more to be achieved from the typically limited shore connection. When the load reduces, the spare power is used to recharge the battery.

Programmable relay

The MultiPlus is equipped with a programmable relay that by default is set as an alarm relay. The relay can be programmed for all kinds of other applications however, for example as a starter relay for a generator.

2.3 Battery Charger

Adaptive 4-stage charge characteristic: bulk – absorption – float – storage

The MultiPlus Compact features a microprocessor controlled 'adaptive' battery management system that can be preset to suit different Types of batteries. The 'adaptive' feature will automatically optimize the process relative to the way the battery is being used.

The right amount of charge: variable absorption time

When only shallow discharges occur (a yacht connected to shore power for example) the absorption time is kept short in order to prevent overcharging of the battery. After a deep discharge the absorption time is automatically increased to make sure that the battery is completely recharged.

Preventing damage due to excessive gassing: the BatterySafe mode

If, in order to quickly charge a battery, a high charge current in combination with a high absorption voltage has been chosen, the MultiPlus Compact will prevent damage due to excessive gassing by automatically limiting the rate of voltage increase once the gassing voltage has been reached.

Less maintenance and aging when the battery is not in use: the Storage mode

The storage mode kicks in whenever the battery has not been subjected to discharge during 24 hours. In the storage mode float voltage is reduced to 2,2V/cell (13,2V for a 12V battery) to minimize gassing and corrosion of the positive plates. Once a week the voltage is raised back to the absorption level to 'equalize' the battery. This feature prevents stratification of the electrolyte and sulphation, a major cause of early battery failure.

To increase battery life: temperature compensation

Every MultiPlus Compact comes with a battery temperature sensor. When connected, charge voltage will automatically decrease with increasing battery temperature. This feature is especially recommended for sealed batteries and/or when important fluctuations of battery temperature are expected.

Learn more about batteries and battery charging

To learn more about batteries and charging batteries, please refer to our book 'Electricity on Board' (available free of charge from Victron Energy and downloadable from www.victronenergy.com). For more information about adaptive charging please look under Technical Briefs on our website.

2.4 Charge Controller MPPT 75/50

Charge current up to 50 A and PV voltage up to 75 V

The BlueSolar MPPT 75/50 charge controller is able to charge a lower nominal-voltage battery from a higher nominal voltage PV array.

Ultra-fast Maximum Power Point Tracking (MPPT)

Especially in case of a clouded sky, when light intensity is changing continuously, an ultra fast MPPT controller will improve energy harvest by up to 30% compared to PWM charge controllers and by up to 10% compared to slower MPPT controllers.

Advanced Maximum Power Point Detection in case of partial shading conditions

If partial shading occurs, two or more maximum power points may be present on the power-voltage curve.

Conventional MPPT's tend to lock to a local MPP, which may not be the optimum MPP. The innovative BlueSolar algorithm will always maximize energy harvest by locking to the optimum MPP.

Outstanding conversion efficiency

No cooling fan. Maximum efficiency exceeds 98%. Full output current up to 40 °C (104 °F).

Flexible charge algorithm

Eight preprogrammed algorithms, selectable with a rotary switch.

Extensive electronic protection

Over-temperature protection and power derating when temperature is high.

PV short circuit and PV reverse polarity protection.
PV reverse current protection.

Internal temperature sensor

Compensates absorption and float charge voltages for temperature.

Adaptive three step charging

The BlueSolar MPPT Charge Controller is configured for a three step charging process: Bulk – Absorption - Float.

Bulk stage

During this stage the controller delivers as much charge current as possible to rapidly recharge the batteries.

Absorption stage

When the battery voltage reaches the absorption voltage setting, the controller switches to constant voltage mode.

When only shallow discharges occur the absorption time is kept short in order to prevent overcharging of the battery. After a deep discharge the absorption time is automatically increased to make sure that the battery is completely recharged. Additionally, the absorption period is also ended when the charge current decreases to less than 2 A.

Float stage

During this stage, float voltage is applied to the battery to maintain it in a fully charged state.

2.5 Configuration Assistants

Several software programs (Assistants) are available to configure the system for various grid interactive or stand alone applications. Please see <http://www.victronenergy.nl/support-and-downloads/software/>

3. OPERATION – inverter/charger

3.1 On/Off/Charger Only Switch

When switched to "on", the product is fully functional. The inverter will come into operation and the LED "inverter on" will light up.

An AC voltage connected to the "AC in" terminal will be switched through to the "AC out" terminal, if within specifications. The inverter will switch off, the "mains on" LED will light up and the charger commences charging. The "bulk", "absorption" or "float" LEDs will light up, depending on the charger mode.

If the voltage at the "AC-in" terminal is not within specifications, the inverter will switch on. When the switch is switched to "charger only", only the battery charger of the MultiPlus will operate (if mains voltage is present). In this mode input voltage also is switched through to the "AC out" terminal.

NOTE: When only the charger function is required, ensure that the switch is switched to "charger only". This prevents the inverter from being switched on if the mains voltage is lost, thus preventing your batteries from running flat.

3.2 Remote control

Remote control is possible with a 3-way switch or with a Digital Multi Control panel. The Control panel has a simple rotary knob with which the maximum current of the AC input can be set: see PowerControl and PowerAssist in Section 2. For the appropriate DIP switch settings, see sect. 5.5.1.

3.3 Equalisation and forced absorption

3.3.1 Equalisation

Traction batteries may require regular equalisation charging. In the equalisation mode, the MultiPlus will charge with increased voltage for one hour (1V above the absorption voltage for a 12V battery, 2V for a 24V battery). The charging current is then limited to 1/4 of the set value. The "bulk" and "absorption" LEDs flash intermittently.



Equalisation mode supplies a higher charging voltage than most DC consuming devices can cope with. These devices must be disconnected before additional charging takes place.

3.3.2 Forced absorption

Under certain circumstances, it can be desirable to charge the battery for a fixed time at absorption voltage level. In Forced Absorption mode, the MultiPlus will charge at the normal absorption voltage level during the set maximum absorption time. The "absorption" LED will be 'on'.

3.3.3 Activating equalisation or forced absorption

The MultiPlus can be put into both these states from the remote panel as well as with the front panel switch, provided that all switches (front, remote and panel) are set to “on” and no switches are set to “charger only”.

In order to put the MultiPlus in this state, the procedure below should be followed.

If the switch is not in the required position after following this procedure, it can be switched over quickly once. This will not change the charging state.

NOTE: Switching from “on” to “charger only” and vice versa, as described below, must be done quickly. The switch must be toggled such that the intermediate position is ‘skipped’, as it were. If the switch remains in the “off” position even for a short time, the device may be turned off. In that case, the procedure must be restarted at step 1. A certain degree of familiarisation is required when using the front switch on the Compact in particular. When using the remote panel, this is less critical.

Procedure:

1. Check whether all switches (i.e. front switch, remote switch or remote panel switch if present) are in the “on” position.
2. Activating equalisation or forced absorption is only meaningful if the normal charging cycle is completed (charger is in ‘Float’).
3. To activate:

- a. Switch rapidly from “on” to “charger only” and leave the switch in this position for ½ to 2 seconds.
- b. Switch rapidly back from “charger only” to “on” and leave the switch in this position for ½ to 2 seconds.
- c. Switch once more rapidly from “on” to “charger only” and leave the switch in this position.
4. On the MultiPlus the three LEDs “Inverter”, “Charger” and “Alarm” will now flash 5 times.

If a MultiControl panel is connected, on the panel the LEDs “bulk”, “absorption” and “float” will also flash 5 times.

5. Subsequently, on the MultiPlus the LEDs “Bulk”, “Absorption” and “Float” will each light during 2 seconds.

If a MultiControl panel is connected, on the panel the LEDs “bulk”, “absorption” and “float” will also each light during 2 seconds.

6.

- a. If the switch on the MultiPlus is set to “on” while the “Bulk” LED lights, the charger will switch to equalisation.

Similarly, if the switch on the MultiControl panel is set to “on” while the “Bulk” LED lights, the charger will switch to equalisation.

- b. If the switch on the MultiPlus is set to “on” while the “Absorption” LED lights, the charger will switch to forced absorption.

Similarly, if the switch on the MultiControl panel is set to “on” while the “Absorption” LED lights, the charger will switch to forced absorption.

- c. If the switch on the MultiPlus is set to “on” after the three LED sequence has finished, the charger will switch to “Float”.

Similarly, if the switch on the MultiControl panel is set to “on” after the three LED sequence has finished, the charger will switch to “float”.

- d. If the switch is has not been moved, the MultiPlus will remain in ‘charger only’ mode and switch to “Float”.

3.4 LED Indications

- LED off
- ☀ LED flashes
- LED illuminated

Inverter

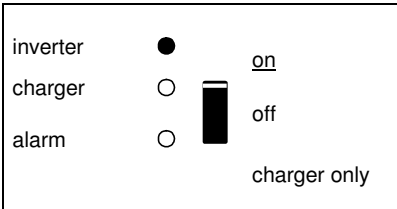

The inverter is switched on and supplies power to the load. Battery operation.

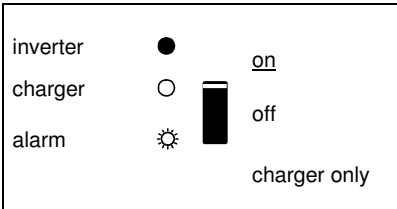

The inverter is switched on and supplies power to the load.
Pre alarm: overload, or battery voltage low, or inverter temperature high

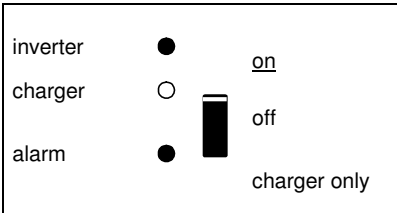

The inverter is switched off.
Alarm: overload, or battery voltage low, or inverter temperature hig, or DC ripple voltage on battery terminal was too high.

Charger

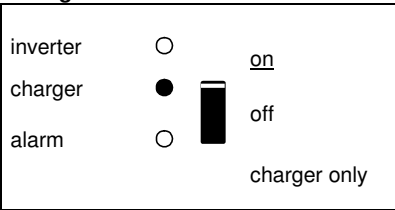

The AC input voltage is switched through and the charger operates in bulk or absorption mode.

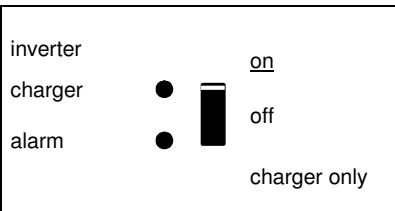

The AC input voltage is switched through and the charger is switched off. The battery charger can not reach battery end voltage (bulk protection mode).

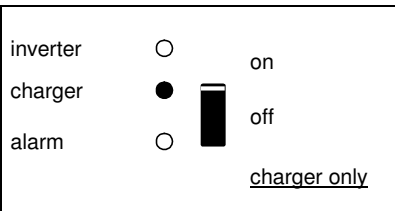

The AC input voltage is switched through and the charger operates in bulk or absorption mode.

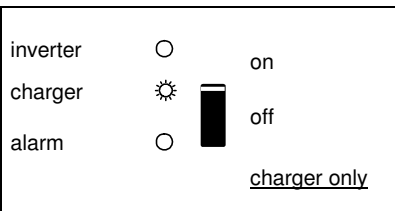

The AC input voltage is switched through and the charger operates in float mode.

4. INSTALLATION – inverter/charger



This product should be installed by a qualified electrician.

4.1 Location

The product must be installed in a dry and well-ventilated area, as close as possible to the batteries. There should be a clear space of at least 10cm around the appliance for cooling.



Excessively high ambient temperature will result in the following:
Reduced service life.
Reduced charging current.
Reduced peak capacity, or shutdown of the inverter.
Never mount the appliance directly above the batteries.

The product is suitable for wall mounting. For mounting see appendix A. The appliance can be mounted horizontally as well as vertically; vertical mounting is preferable. The vertical position offers optimum cooling.



The interior of the product must remain accessible after installation.

Try and keep the distance between the product and the battery to a minimum in order to minimize cable voltage losses.



For safety purposes, this product should be installed in a heat-resistant environment if it is used with equipment where a substantial amount of power is to be converted. You should prevent the presence of e.g. chemicals, synthetic components, curtains or other textiles, etc., in the immediate vicinity.

4.2 Connection of Battery cables

In order to fully utilize the full capacity of the product, batteries with sufficient capacity and battery cables with sufficient cross section should be used. See table.

	24/1600	12/1600
Recommended cross section (mm ²)		
1,5 ¹ → 5 m	35	70
5 → 10 m	70	140

1) preassembled cable length: 1.5 m

Procedure

Proceed as follows to connect the battery cables:



Use an insulated box spanner in order to avoid shorting the battery.
Avoid shorting the battery cables.

Connect the battery cables: the + (red) and the - (black), to the battery see appendix A. Reverse polarity connection (+ to – and – to +) will cause damage to the product. (Safety fuse inside the MultiPlus Compact can be damaged)

Secure the nuts tightly in order to reduce the contact resistance as much as possible.

4.3 Connection of the AC cabling

This is a Safety Class I product (supplied with a protective grounding terminal). **Uninterruptible protective grounding must be provided at the AC input and/or output terminals and/or chassis grounding point located externally on the product.**



The MultiPlus is provided with a ground relay (relay H, see appendix B) that **automatically connects the Neutral output to the chassis if no external AC supply is available**. If an external AC supply is provided, the ground relay H will open before the input safety relay closes. This ensures the correct operation of an earth leakage circuit breaker that is connected to the output.

- In a fixed installation, an uninterruptible grounding can be secured by means of the grounding wire of the AC input. Otherwise the casing must be grounded.
- In a mobile installation (for example, with a shore current plug), interrupting the shore connection will simultaneously disconnect the grounding connection. In that case, the casing must be connected to the chassis (of the vehicle) or to the hull or grounding plate (of the boat).
- In case of a boat, direct connection to the shore ground is not recommended because of potential galvanic corrosion. The solution to this is using an isolation transformer.

The mains -input & output terminal connector can be found on the bottom of the MultiPlus Compact, see appendix A. The shore or mains cable must be connected to the connector with a three-wire cable. Use a three-wire cable with a flexible core and a cross section of 2.5mm².

Procedure

Proceed as follows to connect the AC cables:

The AC output cable can be connected directly to the male-connector. (the connector pulls out!)

The terminal points are indicated clearly. From left to right: "N" (neutral), earth, and "L1" (phase).

The AC input cable can be connected directly to the female-connector. (the connector pulls out!)

The terminal points are indicated clearly. From left to right: "L1" (phase), earth, and "N" (neutral).

Push the "input" connector into the AC-in connector (left-side).

Push the "output" connectors into the AC-out connector (AC0 to AC3 from left to right-side).

4.4 Optional Connections

A number of optional connections are possible:
Undo the four screws at the front of the enclosure and remove the front panel.

4.4.1 Second Battery

The MultiPlus Compact has a connection (+) for charging a starter battery. For connection see appendix 1

4.4.2 Temperature Sensor

The temperature sensor supplied with the product may be used for temperature-compensated charging. The sensor is insulated and must be mounted on the batteries minus pole. Default output voltages for Float and Absorption are at 25°C. In adjust mode temperature compensation is disabled.

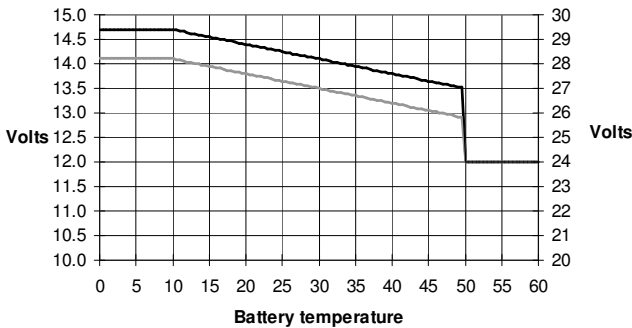

4.4.3 Remote Control panel & remote on/off switch

The product can be remotely controlled in two ways:
- With an external 3-way switch
- With a Multi Control Panel

Please see section 5.5.1. for appropriate DIP switch settings.

Only one remote control can be connected, i.e. either a switch or a remote control panel.

4.4.4. Programmable relay

The MultiPlus is equipped with a multi-functional relay that by default is programmed as an alarm relay. The relay can be programmed for all kinds of other applications however, for example to start a generator (VEConfigure software needed).
Near the connection terminals an LED illuminates when the relay is activated (refer to S, see appendix A)

4.4.5 Parallel Connection

The MultiPlus can be connected in parallel with several identical devices. To this end, a connection is established between the devices by means of standard RJ45 UTP cables. The system (one or more MultiPlus units plus optional control panel) will require subsequent configuration (see Section 5).

In the event of connecting MultiPlus units in parallel, the following requirements must be met:

- A maximum of six units connected in parallel.
- Only identical devices may be connected in parallel.
- The DC connection cables to the devices must be of equal length and cross-section.
- If a positive and a negative DC distribution point is used, the cross-section of the connection between the batteries and the DC distribution point must at least equal the sum of the required cross-sections of the connections between the distribution point and the MultiPlus units.
- Place the MultiPlus units close to each other, but allow at least 10 cm for ventilation purposes under, above and beside the units.
- UTP cables must be connected directly from one unit to the other (and to the remote panel). Connection/splitter boxes are not permitted.
- A battery-temperature sensor need only be connected to one unit in the system. If the temperature of several batteries is to be measured, you can also connect the sensors of other MultiPlus units in the system (with a maximum of one sensor per MultiPlus). Temperature compensation during battery charging responds to the sensor indicating the highest temperature.
- Voltage sensing must be connected to the master (see Section 5.5.1.4).
- If more than three units are connected in parallel in one system, a dongle is required (see Section 5).
- Only one remote control means (panel or switch) can be connected to the system.

4.4.6 Three-phase operation (see appendix D)

The MultiPlus can also be used in 3-phase configuration. To this end, a connection between the devices is made by means of standard RJ45 UTP cables (the same as for parallel operation). The system (MultiPlus units plus an optional control panel) will require subsequently configuration (see Section 5).

Pre-requisites: see Section 4.4.5.

5. CONFIGURATION – inverter/charger



Settings may only be changed by a qualified engineer
Carefully read the instructions before changes are made.
Batteries should be placed in a dry and well-ventilated area during charging.

5.1 Standard settings: ready for use

On delivery, the MultiPlus is set to standard factory values. In general, these settings are suitable for single-unit operation.

Warning: Possibly, the standard battery charging voltage is not suitable for your batteries! Refer to the manufacturer's documentation, or to your battery supplier!

Standard MultiPlus factory settings

Inverter frequency	50 Hz
Input frequency range	45 - 65 Hz
Input voltage range	180 - 265 VAC
Inverter voltage	230 VAC
Stand-alone / parallel / 3-phase	stand-alone
Search mode	off
Ground relay	on
Charger on/ off	on
Battery charge curve	four-stage adaptive with BatterySafe mode
Charge current	75% of the maximum charge current Victron Gel Deep Discharge (also suitable for Victron AGM Deep Discharge)
Automatic equalisation charging	off
Absorption voltage	14.4 / 28.8v
Absorption time	up to 8 hours (depending on bulk time)
Float voltage	13.8 / 27.6V
Storage voltage	13.2 / 26.4V (not adjustable)
Repeated absorption time	1 hour
Absorption repeat interval	7 days
Bulk protection	on
AC input current limit	12A (= adjustable current limit for PowerControl and PowerAssist functions)
UPS feature	on
Dynamic current limiter	off
WeakAC	off
BoostFactor	2
PowerAssist	on
Programmable relay	alarm function



5.2 Explanation of settings

Settings that are not self-explanatory are described briefly below. For further information, please refer to the help files in the software configuration programs (see Section 5.3).

Inverter frequency

Output frequency if no AC is present at the input.

Adjustability: 50Hz; 60Hz

Input frequency range

Input frequency range accepted by the MultiPlus. The MultiPlus synchronises within this range with the AC input frequency. The output frequency is then equal to the input frequency.

Adjustability: 45 – 65 Hz; 45 – 55 Hz; 55 – 65 Hz

Input voltage range

Voltage range accepted by the MultiPlus. The MultiPlus synchronises within this range with the AC input voltage. The output voltage is then equal to the input voltage.

Adjustability:

Lower limit: 180 - 230V

Upper limit: 230 - 270V

Inverter voltage

Output voltage of the MultiPlus in battery operation.

Adjustability: 210 – 245V

Stand-alone / parallel operation / 2-3 phase setting

Using several devices, it is possible to:

increase total inverter power (several devices in parallel)

create a split-phase system

create a 3-phase system.

The standard product settings are for standalone operation. For parallel, three phase or split phase operation see section 4.4.5 and 4.4.6.

Search Mode (Applicable in stand-alone configuration only)

If search mode is 'on', the power consumption in no-load operation is decreased by approx. 70%. In this mode the Compact, when operating in inverter mode, is switched off in case of no load or very low load, and switches on every two seconds for a short period. If the output current exceeds a set level, the inverter will continue to operate. If not, the inverter will shut down again.

The Search Mode can be set with a DIP switch.

The Search Mode "shut down" and "remain on" load levels can be set with VEConfigure.

The standard settings are:

Shut down: 40 Watt (linear load)

Turn on: 100 Watt (linear load)

AES (Automatic Economy Switch)

Instead of the search mode, the AES mode can also be chosen (with help of VEConfigure only).

If this setting is turned 'on', the power consumption in no-load operation and with low loads is decreased by approx. 20%, by slightly 'narrowing' the sinusoidal voltage.

Not adjustable with DIP switches.

Applicable in stand-alone configuration only.

Ground relay (see appendix B)

With this relay (H), the neutral conductor of the AC output is grounded to the chassis when the back feed safety relay is open. This ensures the correct operation of earth leakage circuit breakers in the output.

If a non-grounded output is required during inverter operation, this function must be turned off. (See also Section 4.5)

Not adjustable with DIP switches.

Battery charge curve

The standard setting is 'Four-stage adaptive with BatterySafe mode'. See Section 2 for a description.

This is the recommended charge curve. See the help files in the software configuration programs for other features.

Battery type

The standard setting is the most suitable for Victron Gel Deep Discharge, Gel Exide A200, and tubular plate stationary batteries (OPzS). This setting can also be used for many other batteries: e.g. Victron AGM Deep Discharge and other AGM batteries, and many types of flat-plate open batteries. Four charging voltages can be set with DIP switches.

Automatic equalisation charging

This setting is intended for tubular plate traction batteries. During absorption the voltage limit increases to 2,83V/cell (34V for a 24V battery) once the charge current has tapered down to less than 10% of the set maximum current.

Not adjustable with DIP switches.

See 'tubular plate traction battery charge curve' in VEConfigure.

Absorption time

The absorption time depends on the bulk time (adaptive charge curve), so that the battery is optimally charged. If the 'fixed' charging characteristic is selected, the absorption time is fixed.

For most batteries, a maximum absorption time of eight hours is suitable. If an extra high absorption voltage is selected for rapid charging (only possible for open, flooded batteries!), four hours is preferable. With DIP switches, a time of eight or four hours can be set. For the adaptive charge curve, this determines the maximum absorption time.

Storage voltage, Repeated Absorption Time, Absorption Repeat Interval

See Section 2. Not adjustable with DIP switches.

Bulk Protection

When this setting is 'on', the bulk charging time is limited to 10 hours. A longer charging time could indicate a system error (e.g. a battery cell short-circuit). Not adjustable with DIP switches.

AC input current limit

These are the current limit settings at which PowerControl and PowerAssist come into operation. The factory setting is 12A.

See Section 2, the book 'Energy Unlimited', or the many descriptions of this unique feature on our website www.victronenergy.com.

Remark: lowest allowable current setting for PowerAssist: 2,7A.

(2,7A per unit in case of parallel operation)

UPS feature

If this setting is 'on' and AC on the input fails, the MultiPlus switches to inverter operation practically without interruption. The MultiPlus can therefore be used as an Uninterruptible Power Supply (UPS) for sensitive equipment such as computers or communication systems. The output voltage of some small generator sets is too unstable and distorted for using this setting* – the MultiPlus would continually switch to inverter operation. For this reason, the setting can be turned off. The MultiPlus will then respond less quickly to AC input voltage deviations. The switchover time to inverter operation is consequently slightly longer, but most equipment (most computers, clocks or household equipment) is not adversely impacted. Recommendation: Turn the UPS feature off if the MultiPlus fails to synchronise, or continually switches back to inverter operation.

*In general, the UPS setting can be left 'on' if the MultiPlus is connected to a generator with a 'synchronous AVR regulated alternator'.

The UPS mode may have to be set to 'off' if the MultiPlus is connected to a generator with a 'synchronous capacitor regulated alternator' or an asynchronous alternator.

Dynamic current limiter

Intended for generators, the AC voltage being generated by means of a static inverter (so-called 'inverter' generators). In these generators, rpm is down-controlled if the load is low: this reduces noise, fuel consumption and pollution. A disadvantage is that the output voltage will drop severely or even completely fail in the event of a sudden load increase. More load can only be supplied after the engine is up to speed.

If this setting is 'on', the MultiPlus will start supplying extra power at a low generator output level and gradually allow the generator to supply more, until the set current limit is reached. This allows the generator engine to get up to speed.

This setting is also often used for 'classic' generators that respond slowly to sudden load variation.

WeakAC

Strong distortion of the input voltage can result in the charger hardly operating or not operating at all. If WeakAC is set, the charger will also accept a strongly distorted voltage, at the cost of greater distortion of the input current.

Recommendation: Turn WeakAC on if the charger is hardly charging or not charging at all (which is quite rare!). Also turn on the dynamic current limiter simultaneously, and reduce the maximum charging current to prevent overloading the generator if necessary.

Not adjustable with DIP switches.

BoostFactor

Change this setting only after consulting with Victron Energy or with an engineer trained by Victron Energy!

Not adjustable with DIP switches.

Programmable relay

By default, the programmable relay is set as an alarm relay, i.e. the relay will de-energise in the event of an alarm or a pre-alarm (inverter almost too hot, ripple on the input almost too high, battery voltage almost too low).

Not adjustable with DIP switches.

Near the connection terminals an LED illuminates when the relay is activated.

VEConfigure

With VEConfigure software the relay can also be programmed for other purposes, for example to provide a generator starting signal.

5.3 Configuration by computer

All settings can be changed by means of a computer. Some settings can be changed with DIP switches (see Section 5.2).

For changing settings with the computer, the following is required:

- VEConfigureII software or the appropriate Assistant(s): can be downloaded free of charge at www.victronenergy.com.

- A RJ45 UTP cable and the **MK2.2b** RS485-to-RS232 interface. If the computer has no RS232 connection, but does have USB, a **RS232-to-USB interface cable** is needed.

Both are available from Victron Energy.

5.3.1 VE.Bus Quick Configure Setup

VE.Bus Quick Configure Setup is a software program with which one Compact unit or systems with a maximum of three Compact units (parallel or three phase operation) can be configured in a simple manner. VEConfigureII forms part of this program.

The software free can be downloaded free of charge at www.victronenergy.com.

For connection to the computer, a RJ45 UTP cable and the **MK2.2b** RS485-to-RS232 interface is required.

If the computer has no RS232 connection, but does have USB, a **RS232-to-USB interface cable** is needed. Both are available from Victron Energy.

5.3.2 VE.Bus System Configurator

For configuring advanced applications and/or systems with four or more MultiPlus units,

VE.Bus System Configurator software must be used. The software can be downloaded free of charge at www.victronenergy.com. VEConfigureII forms part of this program.

For connection to the computer, a RJ45 UTP cable and the **MK2.2b** RS485-to-RS232 interface is required.

If the computer has no RS232 connection, but does have USB, a **RS232-to-USB interface cable** is needed. Both are available from Victron Energy.

5.4 Configuration with a VE.Net panel

To this end, a VE.Net panel and the VE.Net to VE.Bus converter are required.

With VE.Net you can set all parameters, with the exception of the multi-functional relay and the VirtualSwitch.

5.5 Configuration with DIP switches

Some settings can be changed with DIP switches.

Procedure:

- a) Turn the Compact on, preferably without load and without AC voltage on the inputs. The Compact will then operate in inverter mode.
- b) Set the dipswitches as required.
- c) Store the settings by moving Dip switch 8 to “on” and back to “off”.

5.5.1. DIP switch 1 and 2

Default setting: to operate the product with the “On/Off/Charger Only” switch

ds 1: “off”

ds 2: “on”

The default setting is required when using the “On/Off/Charger Only” switch in the front panel.

Setting for remote operation with a Multi Control Panel:

ds 1: “on”

ds 2: “off”

This setting is required when a Multi Control Panel is connected.

The Multi Control panel must be connected to one of the two RJ48 sockets B, see appendix A.

Setting for remote operation with a 3-way switch:

ds 1: “off”

ds 2: “off”

This setting is required when a 3-way switch is connected.

The 3-way switch must be wired to terminal L, see appendix A.

Only one remote control can be connected, i.e. either a switch or a remote control panel.

In both cases the switch on the product itself should be “on”.

5.5.2. DIP switch 3 to 7

These DIP switches can be used to set:

- Battery charge voltage and Absorption time
- Inverter frequency
- Search mode
- AC input current limit 12A or 6A

ds3-ds4: Setting charge voltages

ds3-ds4	Absorption voltage	Float voltage	Storage Voltage	Absorption Time (hours)	Suitable for
dS3=off dS4=off (default)	14.4 28.8 57.6	13.8 27.6 55.2	13.2 26.4 52.8	8	Gel Victron Deep Discharge Gel Exide A200 AGM Victron Deep Discharge
dS3=on dS4=off	14.1 28.2 56.4	13.8 27.6 55.2	13.2 26.4 52.8	8	Gel Victron Long Life (OPzV) Gel Exide A600 (OPzV) Gel MK battery
dS3=off dS4=on	14.7 29.4 58.8	13.8 27.6 55.2	13.2 26.4 52.8	5	AGM Victron Deep Discharge Tubular plate or OPzS batteries in semi-float mode AGM spiral cell
dS3=on dS4=on	15.0 30.0 60.0	13.8 27.6 55.2	13.2 26.4 52.8	6	Tubular plate or OPzS batteries in cyclic mode

Batteries with high antimony content can typically be charged with a lower absorption voltage than batteries with low antimony content. (Please refer to our book “Electricity on Board” downloadable from our website www.victronenergy.com for details and suggestions about charging batteries). Contact your battery supplier for the correct charge voltages and change (with VE-configure) the voltage settings if required.

The default charge current setting is 75% of the maximum charge current. This current will be too high for most applications.

For most battery types the optimal charge current is 0.1-0.2x the battery capacity.

ds5: Inverter frequency off = 50 Hz on = 60 Hz

ds6: Search Mode off = off on = on

ds7: AC input current limit off = 12 Amp on = 4 Amp

Store the settings by moving Dip switch 8 to “on” and back to “off”.

5.5.3 Exemplary settings

Example 1 is the factory setting (since factory settings are entered by computer, all DIP switches of a new product are set to 'off', except for DS-2).

DS-1 Panel option DS-2 Panel option DS-3 Ch. voltage DS-4 Ch. voltage DS-5 Frequency DS-6 Search mode DS-7 AC-in Limit DS-8 Store setting		DS-1 DS-2 DS-3 DS-4 DS-5 DS-6 DS-7 DS-8		DS-1 DS-2 DS-3 DS-4 DS-5 DS-6 DS-7 DS-8	
Example 1: (factory setting) 1 No panel or remote switch connected 2 No panel or remote switch connected 3, 4 GEL 14.4 V 5 Frequency: 50Hz 6 Search mode off 7 AC-in Limit 12 Amp 8 Store setting: off→ on→ off	Example 2 1 No panel or remote switch connected 2 No panel or remote switch connected 3,4 AGM 14,7V 5 Frequency: 50Hz 6 Search mode off 7 AC-in Limit 4 Amp 8 Store setting: off→ on→ off	Example 3 1 Panel or remote switch connected 2 Panel or remote switch connected 3, 4 Tubular plate 15V 5 Frequency: 60Hz 6 Search mode on 7 AC-in Limit 12 Amp 8 Store setting: off→ on→ off			

Store the settings (DS3-DS7) by changing switch ds-8 from off to on, and then back to off. The LED's 'charger' and 'alarm' will flash to indicate acceptance of the settings.

6. TROUBLE SHOOTING TABLE – inverter/charger

Proceed as follows for quick detection of common faults.

DC loads must be disconnected from the batteries and the AC loads must be disconnected from the inverter before the inverter and/ or battery charger is tested.

Consult your Victron Energy dealer if the fault cannot be resolved.

Problem	Cause	Solution
The inverter fails to operate when switched on.	The battery voltage is too high or too low.	Ensure that the battery voltage is within the correct value.
The inverter fails to operate	Processor in no function-mode.	Disconnect mains voltage. Switch Front switch off, wait 4 seconds Switch front switch on.
The alarm LED flashes.	Pre-alarm alt. 1. The DC input voltage is low.	Charge the battery or check the battery connections.
The alarm LED flashes	Pre-alarm alt. 2. The ambient temperature is too high.	Place the inverter in a cool and well-ventilated room, or reduce the load.
The alarm LED flashes.	Pre-alarm alt. 3. The load on the inverter is higher than the nominal load.	Reduce the load.
The alarm LED flashes.	Pre-alarm alt. 4. Voltage ripple on the DC input exceeds 1.25Vrms.	Check the battery cables and terminals. Check the battery capacity; increase if necessary.
The alarm LED flashes intermittently.	Pre-alarm alt. 5. Low battery voltage and excessive load.	Charge the batteries, reduce the load or install batteries with a higher capacity. Use shorter and/or thicker battery cables.
The alarm LED is on	The inverter did cut out following a pre-alarm.	Check the table for the appropriate course of action.

Problem	Cause	Solution
The charger is not functioning	The AC input voltage or frequency is out of range.	Ensure that the input voltage is between 185 Vac and 265 Vac, and that the frequency matches the setting.
	The thermal circuit breaker has tripped.	Reset the 16 A thermal circuit breaker.
The battery is not being charged fully.	Incorrect charging current.	Set the charging current at between 0.1 and 0.2x battery capacity.
	A defective battery connection.	Check the battery terminals.
	The absorption voltage has been set to an incorrect value.	Adjust the absorption voltage to the correct value.
	The float voltage has been set to an incorrect value.	Adjust the float voltage to the correct value.
	The internal DC fuse is defective.	Inverter is damaged.
The battery is overcharged.	The absorption voltage has been set to an incorrect value.	Adjust the absorption voltage to the correct value.
	The float voltage has been set to an incorrect value.	Adjust the float voltage to the correct value.
	A defective battery.	Replace the battery.
	The battery is too small.	Reduce the charging current or use a battery with a higher capacity.
	The battery is too hot.	Connect a temperature sensor.
Battery charge current drops to 0 when the absorption voltage is reached	Alt. 1: Battery overtemperature (> 50 °C)	- Allow battery to cool down - Place battery in a cool environment - Check for shorted cells
	Alt 2: Battery temperature sensor faulty	Unplug battery temperature sensor from the MultiPlus. Reset the MultiPlus by switching it off, then wait for 4 seconds and switch it on again If the MultiPlus now charges normally, the battery temperature sensor is faulty and needs to be replaced

7. INSTALLATION – solar charge controller



- Protect the solar modules from incident light during installation, e.g. cover them.
- Never touch uninsulated cable ends.
- Use only insulated tools.

7.1 Connection of the solar panels

Up to three strings of PV panels can be connected with three sets of MC4 (PV-ST01) PV connectors.

7.2 PV configuration

- The controller will **operate only if the PV voltage exceeds battery voltage (Vbat)**.
- PV voltage must exceed $V_{bat} + 5V$ for the controller to start. Thereafter minimum PV voltage is $V_{bat} + 1V$.
- Maximum open circuit PV voltage: 75V.

The controller can be used with any PV configuration that satisfies the three above mentioned conditions.

For example:

24V battery and mono- or polycrystalline panels

- Minimum number of cells in series: 72 (2x 12V panel in series or 1x 24V panel).
- Maximum: 108 cells (3x 12V panel in series).

Remark: at low temperature the open circuit voltage of a 108 cell solar array may exceed 75 V, depending on local conditions and cell specifications. In that case the number of cells in series must be reduced.

7.3 Cable connection sequence (see figure 1)

First: connect the battery.

Second: connect the solar array (when connected with reverse polarity, the controller will heat up but will not charge the battery).

8. CONFIGURATION – the solar charge controller

Eight preprogrammed charge algorithms, selectable with a rotary switch (see appendix A):

Pos	Suggested battery type	Absorption V	Float V	dV/dT mV/°C
0	Gel Victron long life (OPzV) Gel exide A600 (OPzV) Gel MK	28,2	27,6	-32
1	Gel Victron deep discharge Gel Exide A200 AGM Victron deep discharge Stationary tubular plate (OPzS) Rolls Marine (flooded) Rolls Solar (flooded)	28,6	27,6	-32
2	Default setting Gel Victron deep discharge Gel Exide A200 AGM Victron deep discharge Stationary tubular plate (OPzS) Rolls Marine (flooded) Rolls Solar (flooded)	28,8	27,6	-32
3	AGM spiral cell Stationary tubular plate (OPzS) Rolls AGM	29,4	27,6	-32
4	PzS tubular plate traction batteries or OPzS batteries	29,8	27,6	-32
5	PzS tubular plate traction batteries or OPzS batteries	30,2	27,6	-32
6	PzS tubular plate traction batteries or OPzS batteries	30,6	27,6	-32
7	Lithium Iron Phosphate (LiFePo ₄) batteries	28,4	27,0	0

After changing the position of the rotary switch, the LED's will blink during 4 seconds as follows:

Switch position	LED Float	LED Abs	LED Bulk	Blink frequency
0	1	1	1	fast
1	0	0	1	slow
2	0	1	0	slow
3	0	1	1	slow
4	1	0	0	slow
5	1	0	1	slow
6	1	1	0	slow
7	1	1	1	slow

Thereafter, normal indication resumes, as described below.

Remark: the blink function is enabled only when PV power is present on the input of the controller.

8.1 LED's

Blue LED “bulk”: will be on when the battery has been connected
Switches off when the absorption voltage is reached.

Blue LED “absorption”: will be on when the absorption voltage is reached.
Switches off at the end of the absorption period.

Blue LED “float”: will be on after the solar charger has switched to float.

8.2 Battery charging information

The charge controller starts a new charge cycle every morning, when the sun starts shining. The maximum duration of the absorption period is determined by the battery voltage measured just before the solar charger starts up in the morning:

Battery voltage Vb (@start-up)	Maximum absorption time
Vb < 23,8V	4 h
23,8V < Vb < 24,4V	2 h
24,4V < Vb < 25,2V	1 h
Vb > 25,2V	0 h

If the absorption period is interrupted due to a cloud or due to a power hungry load, the absorption process will resume when absorption voltage is reached again later on the day, until the absorption period has been completed.

The absorption period also ends when the output current of the solar charger drops to less than 2 Amps, not because of low solar array output but because the battery is fully charged (tail current cut off).

This algorithm prevents over charge of the battery due to daily absorption charging when the system operates without load or with a small load.

8.3 Connectivity

Several parameters can be customized (VE.Direct to USB cable, ASS030530000, and a computer needed). See the data communication white paper on our website.

The required software can be downloaded from <http://www.victronenergy.nl/support-and-downloads/software/>

The charge controller can be connected the to a Color Control panel, BPP000300100R, with a VE.Direct to VE.Direct cable.

9. TROUBLESHOOTING – solar charge controller

Problem	Possible cause	Solution
Charger does not function	Reversed PV connection	Connect PV correctly
	Reverse battery connection	Non replacable fuse blown. Return to VE for repair
The battery is not fully charged	A bad battery connection	Check battery connection
	Cable losses too high	Use cables with larger cross
	Large ambient temperature difference between charger and battery	Make sure that ambient conditions are equal for charger and battery
	Only for a 24V system: wrong system voltage chosen (12V instead of 24V) by the charge controller	Disconnect PV and battery, after making sure that the battery voltage is at least >19V, reconnect properly (reconnect battery first)
The battery is being overcharged	A battery cell is defect	Replace battery
	Large ambient temperature difference between charger and battery ($T_{\text{ambient_chrg}} < T_{\text{ambient_batt}}$)	Make sure that ambient conditions are equal for charger and battery

9. MAINTENANCE

This product does not require specific maintenance. It will suffice to check all connections once a year. Avoid moisture and oil/soot/vapours, and keep the device clean.



10. TECHNICAL DATA

EasySolar	EasySolar 12/1600/70	EasySolar 24/1600/40
Inverter/charger		
PowerControl / PowerAssist	Yes	
Transfer switch	16 A	
INVERTER		
Input voltage range	9,5 – 17 V	19 – 33 V
“Heavy duty” output AC 0	16 A	
Output AC1, 2, 3	Output voltage: 230 VAC ± 2% Frequency: 50 Hz ± 0,1% (1)	
Cont. output power at 25 °C (3)	1600 VA / 1300 W	
Cont. output power at 40 °C	1200 W	
Peak power	3000 W	
Maximum efficiency	92%	94%
Zero-load power	8 W	10 W
Zero load power in search mode	2 W	3 W
CHARGER		
AC Input	Input voltage range: 187-265 VAC Input frequency: 45 – 65 Hz Power factor: 1	
Charge voltage 'absorption'	14,4 / 28,8 V	
Charge voltage 'float'	13,8 / 27,6 V	
Storage mode	13,2 / 26,4 V	
Charge current house battery (4)	70 A	40 A
Battery temperature sensor	yes	
Programmable relay (5)	yes	
Protection (2)	a - g	
Solar Charge Controller		
Maximum battery current	50 A	
Maximum PV power, (6a,b)	700 W	1400 W
Maximum PV open circuit voltage	75 V	
Maximum efficiency	98 %	
Self-consumption	10 mA	
Charge voltage 'absorption', default setting	14,4 V	28,8 V
Charge voltage 'float', default setting	13,8 V	27,6 V
Charge algorithm	multi-stage adaptive	
Temperature compensation	-16 mV / °C resp. -32 mV / °C	
Protection	a - g	

Common Characteristics	
Operating temp. range	-20 to +50 °C (fan assisted cooling)
Humidity (non condensing):	max 95%
ENCLOSURE	
Material & Colour	aluminium (blue RAL 5012)
Protection category	IP21
Battery-connection	Battery cables of 1.5 meter
PV connection	Three sets of MC4 (PV-ST01) PV connectors
230 V AC-connection	G-ST18i connector
Weight	11,7 kg
Dimensions (hwxwd)	510x214x110 mm
STANDARDS	
Safety	EN 60335-1, EN 60335-2-29, EN 62109
Emission / Immunity	EN55014-1, EN 55014-2, EN 61000-3-3
Automotive Directive	2004/104/EC

- 1) Can be adjusted to 60Hz and to 240V
- 2) Protection
 - a. Output short circuit
 - b. Overload
 - c. Battery voltage too high
 - d. Battery voltage too low
 - e. Temperature too high
 - f. 230VAC on inverter output
 - g. Input voltage ripple too high
- 3) Non linear load, crest factor 3:1
- 4) At 25 °C ambient
- 5) Programmable relay which can be set for general alarm, DC undervoltage or genset start signal function
- 6a) If more PV power is connected, the controller will limit input power to 720W resp. 1440W.
- 6b) PV voltage must exceed $V_{bat} + 5V$ for the controller to start.
Thereafter minimum PV voltage is $V_{bat} + 1V$.



Appendix A: overview connections on inverter pcb

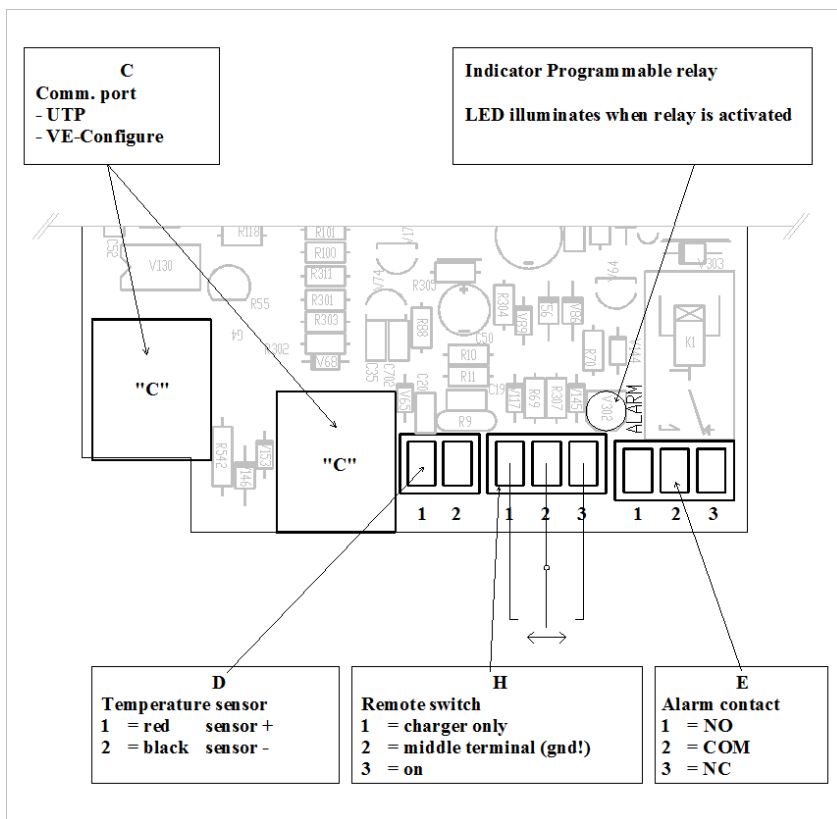

Appendix A: bottom of chassis

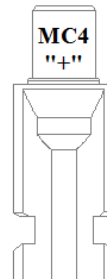
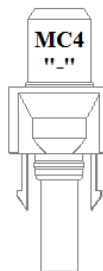
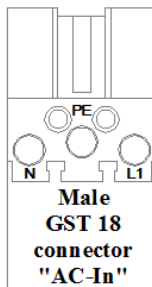
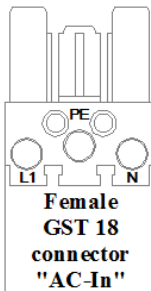
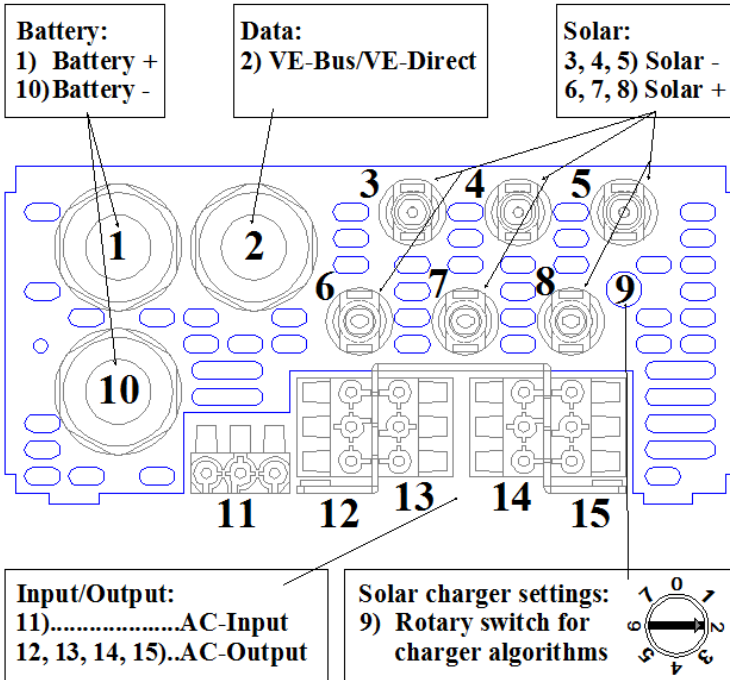

Appendix B: installation information

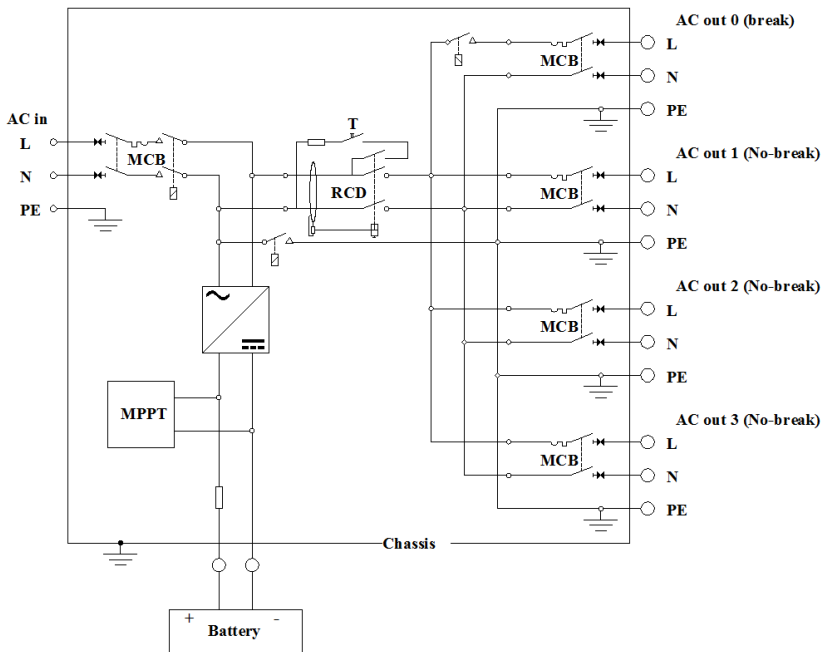

Victron Energy Blue Power

Distributor:

Serial number:

Version : 01
Date : 11 March 2014

Victron Energy B.V.
De Paal 35 | 1351 JG Almere
PO Box 50016 | 1305 AA Almere | The Netherlands

General phone : +31 (0)36 535 97 00
Customer support desk : +31 (0)36 535 97 03
Fax : +31 (0)36 535 97 40

E-mail : sales@victronenergy.com

www.victronenergy.com